

TYPE T34

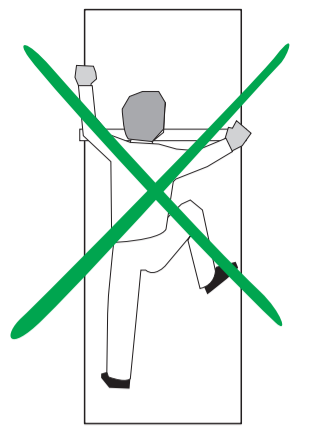

40023043

© Copyright by PBO 29/10/2020

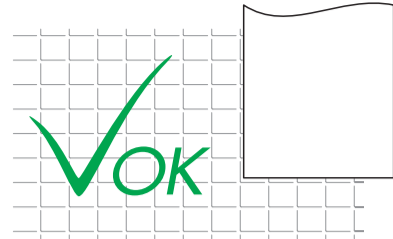
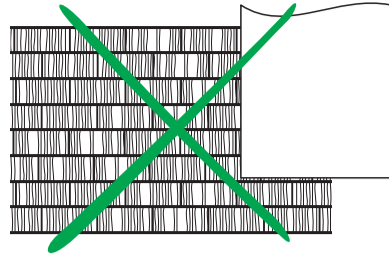
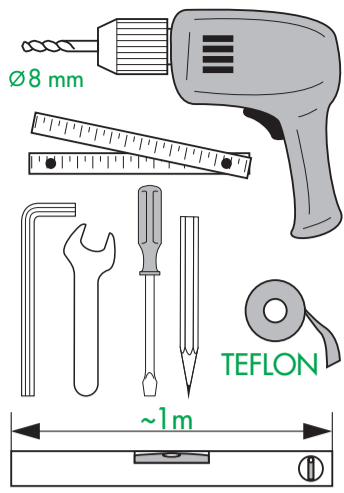
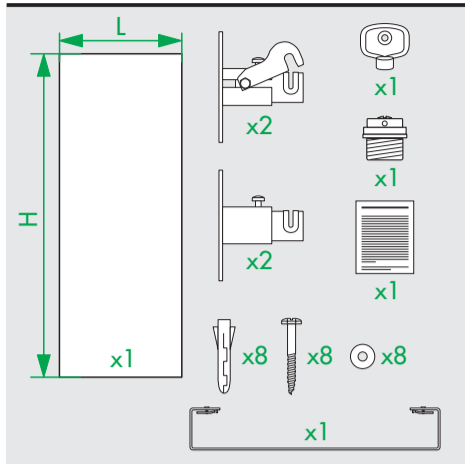

DE Geeignete Befestigungsschrauben je nach Beschaffenheit der Wand verwenden.
EN Use mounting screws suitable for your wall.
ES Utilizar un sistema de fijación adecuado al tipo de pared.
FR Utiliser des vis de fixation adaptées à la nature de votre mur.
IT D'impiegare un sistema di fissaggio adatto al tipo di muro.
NL Gebruik montageschroeven die geschikt zijn voor de aard van de wand.
PL Używać śrub mocujących przystosowanych do rodzaju ściany.

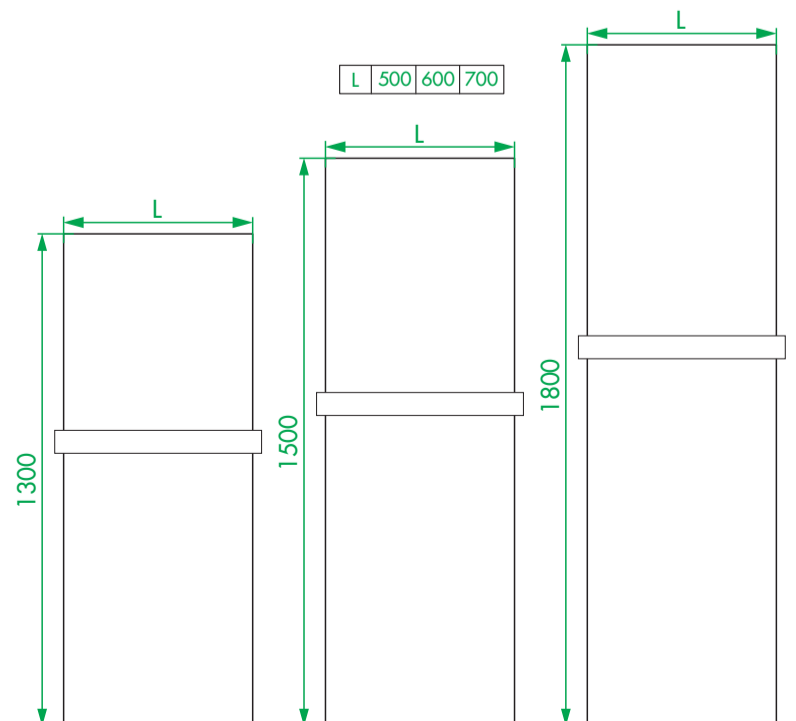
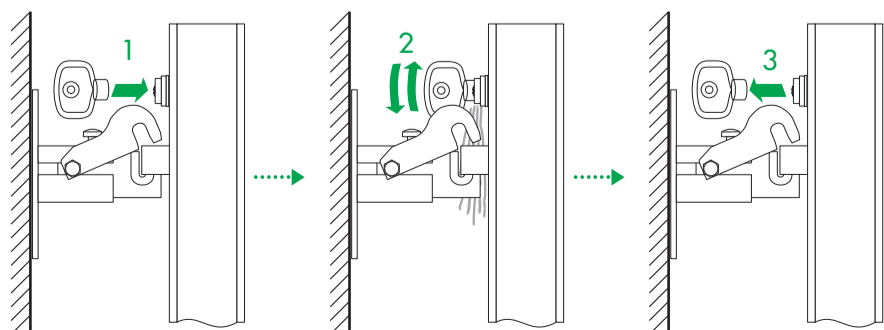
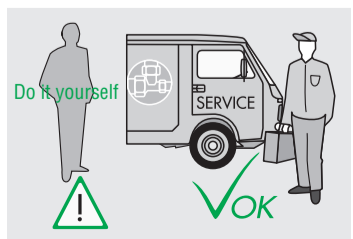
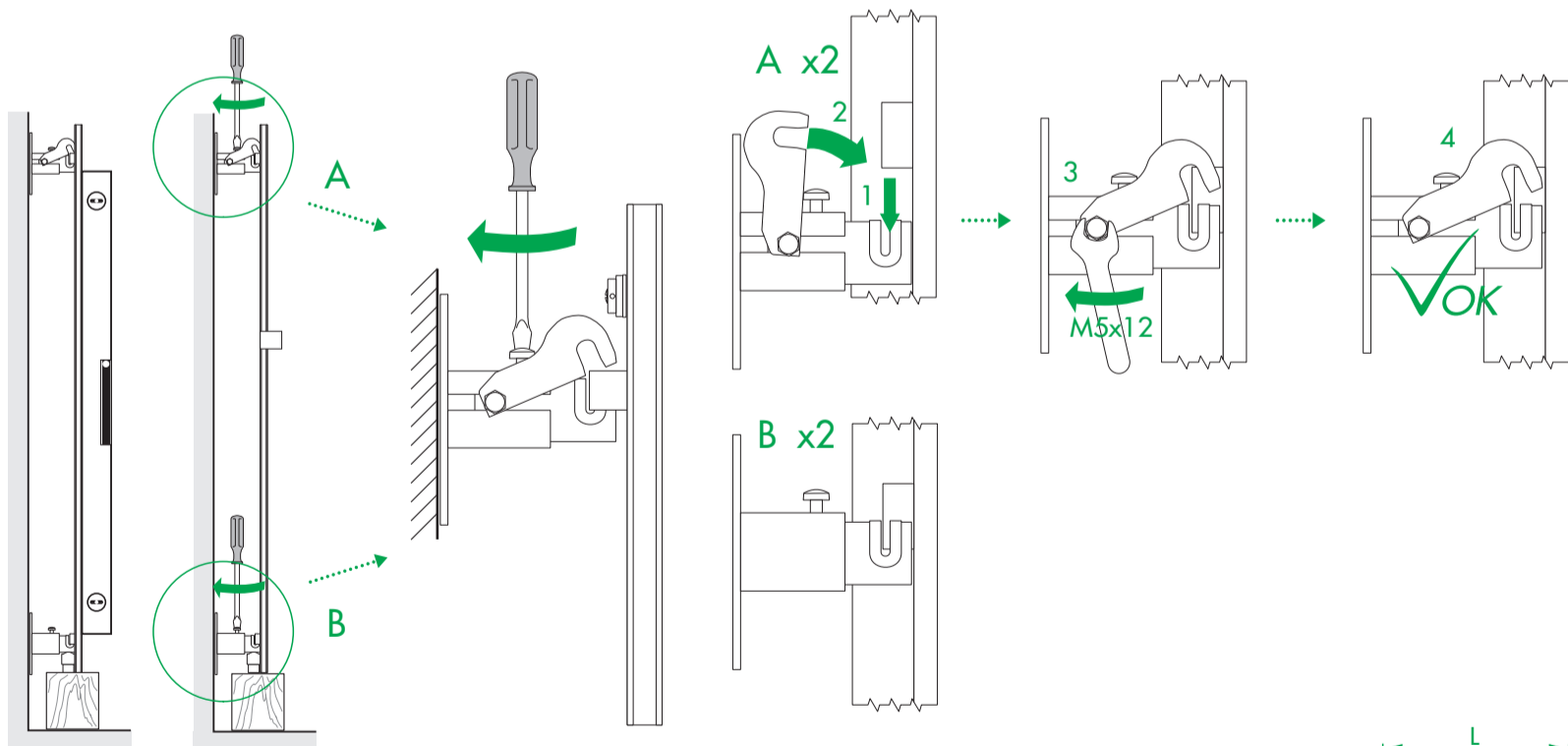
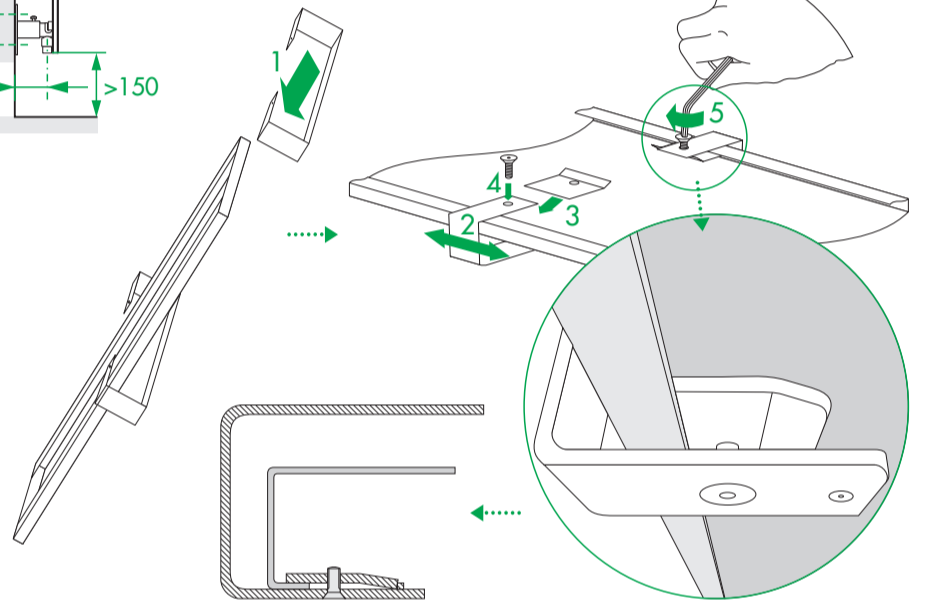
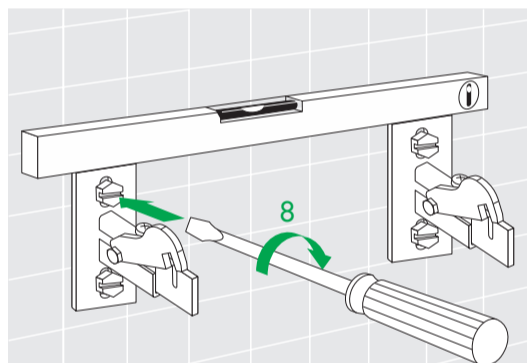
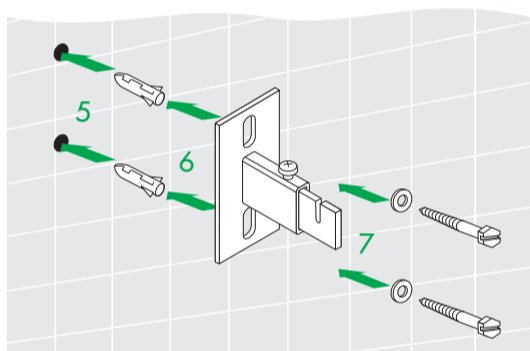
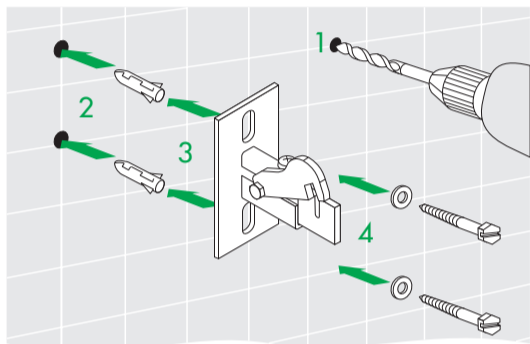
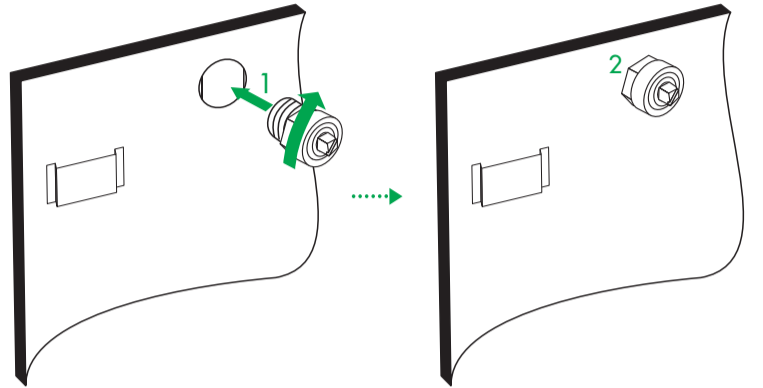
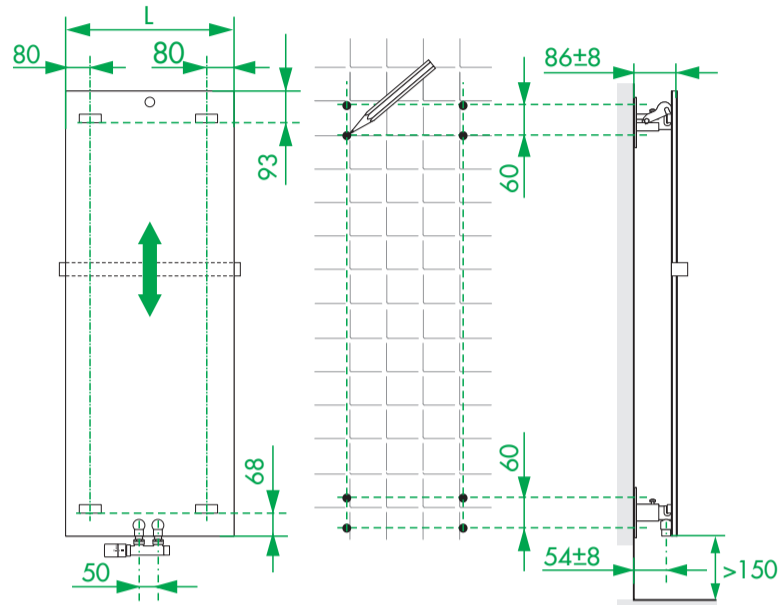

TYPE T34E

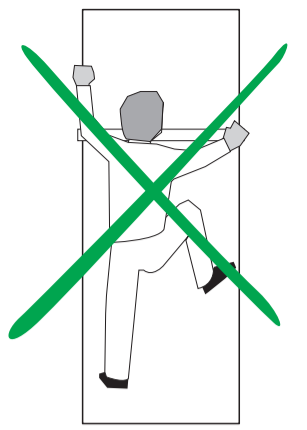
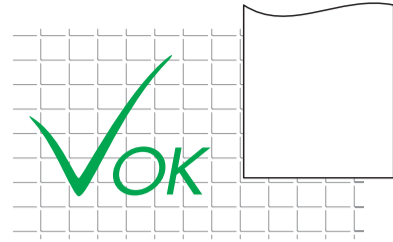
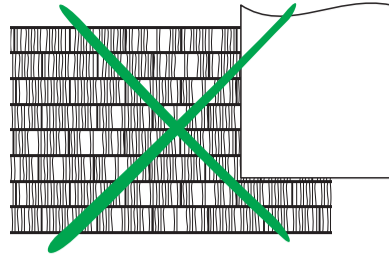
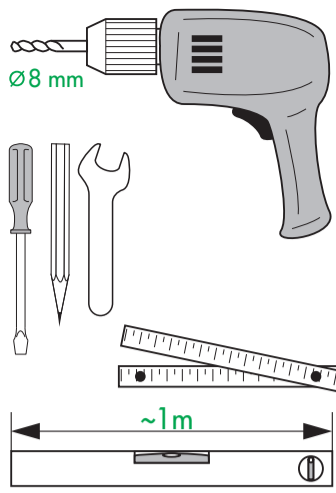
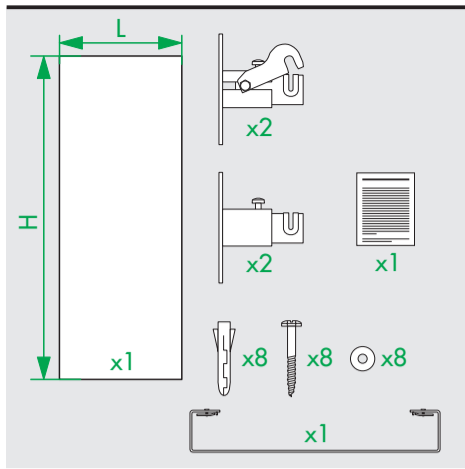

DE Geeignete Befestigungsschrauben je nach Beschaffenheit der Wand verwenden.

EN Use mounting screws suitable for your wall.

ES Utilizar un sistema de fijación adecuado al tipo de pared.

FR Utiliser des vis de fixation adaptées à la nature de votre mur.

IT D'impiegare un sistema di fissaggio adatto al tipo di muro.

NL Gebruik montageschroeven die geschikt zijn voor de aard van de wand.

PL Używać śrub mocujących przystosowanych do rodzaju ściany.

